

GT

Pag. A1

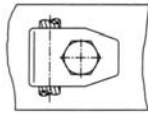
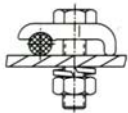

1/2 GT

Pag. A1

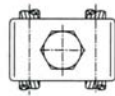
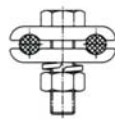

GT1

Pag. A1

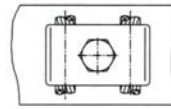
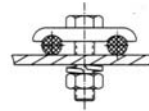

1/2 GT1

Pag. A1

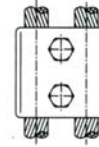
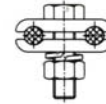

GT2

Pag. A1

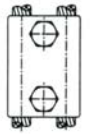
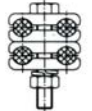

GT4

Pag. A2

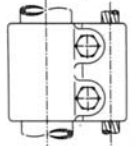
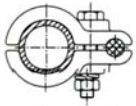

GBC

Pag. A2

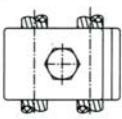
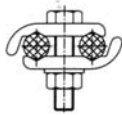

GUE

Pag. A2

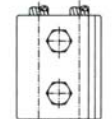
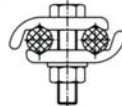

GU

Pag. A2

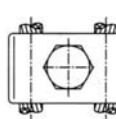
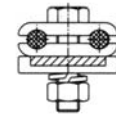

GT1P

Pag. A3

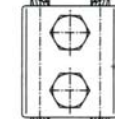
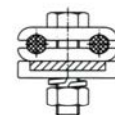

GT2P

Pag. A3

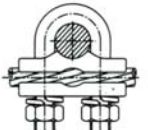
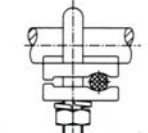

GP

Pag. A3

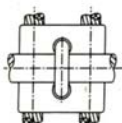
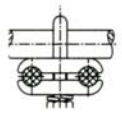

GDP

Pag. A3

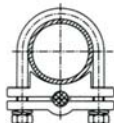
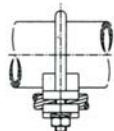

GC

Pag. A4

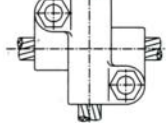
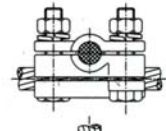

GX

Pag. A4

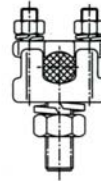

GE

Pag. A4

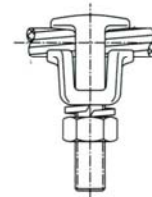

GV

Pag. A5

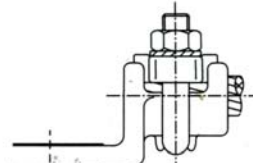

RVP

Pag. A5

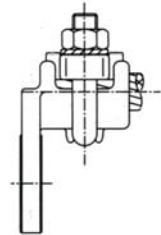

LVP

Pag. A5

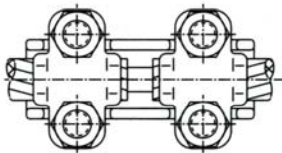

RVV

Pag. A5

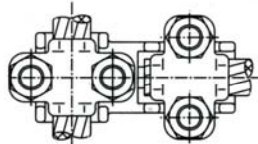

DVV

Pag. A5

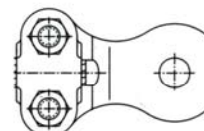

RTP

Pag. A6

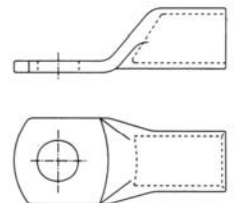

RP

Pag. A6



EARTHING CONNECTORS

ЗАЖИМЫ ЗАЗЕМЛИТЕЛЕЙ

RACCORDS DE MISE À TERRE



EARTH ING CLAMP FOR CU. CABLE UPON STRUCTURE

ЗАЖИМЫ ЗАЗЕМЛИТЕЛЕЙ ДЛЯ МЕДНЫХ ПРОВОДОВ

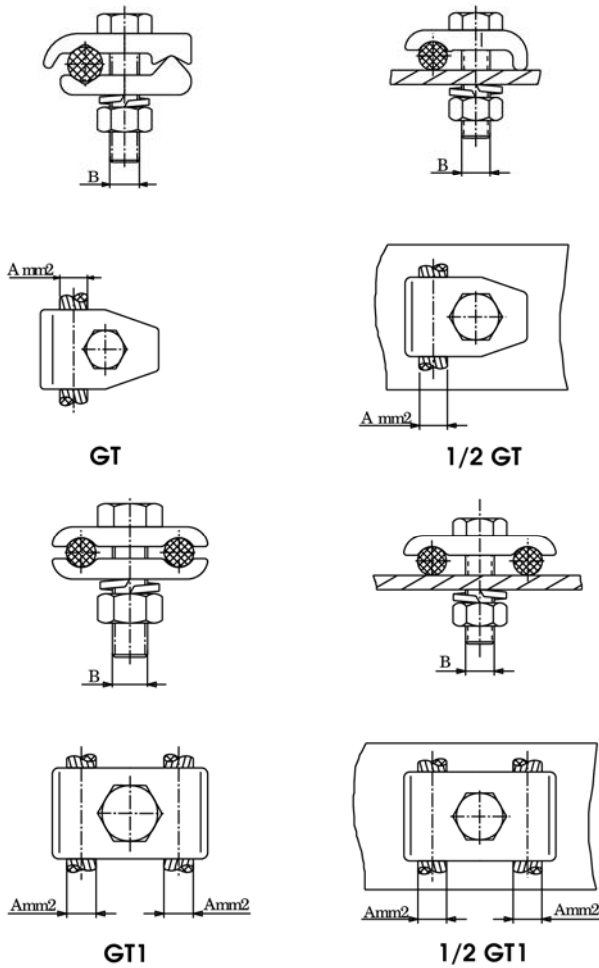

Referencia Code Шифр	mm ²		B	Par de apriete Tightening torque Момент затяжки (kg.m)
	A			
	Mín.	Máx.		
GT-70/M8	50	70	M-8	2
GT-70/M10	50	70	M-10	3
GT-70/M12	50	70	M-12	5
GT-150/M10	50	160	M-10	3
GT-150/M12	50	160	M-12	5

1/2GT-70/M8	50	70	M-8	2
1/2GT-70/M10	50	70	M-10	3

GT1-70/M10	50	70	M-10	3
GT1-70/M12	50	70	M-12	5
GT1-150/M10	95	150	M-10	3
GT1-150/M12	95	150	M-12	5

1/2GT1-70/M10	50	70	M-10	3
1/2GT1-70/M12	50	70	M-12	5
1/2GT1-150/M10	95	150	M-10	3
1/2GT1-150/M12	95	150	M-12	5

EARTHING CLAMP FOR 2 CU. CABLES UPON STRUCTURE

ЗАЖИМЫ ЗАЗЕМЛИТЕЛЕЙ ДЛЯ ДВУХ МЕДНЫХ ПРОВОДОВ

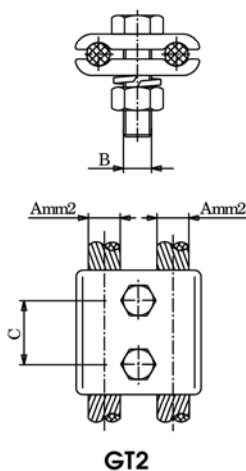

Referencia Code Шифр	mm. ²		B	mm. C	Par de apriete Tightening torque Момент затяжки (kg.m)
	A				
	Mín.	Máx.			
GT2-70/32-M10	50	70	M-10	32	3
GT2-70/32-M12	50	70	M-12	32	5
GT2-150/32-M10	95	150	M-10	32	3
GT2-150/32-M12	95	150	M-12	32	5
GT2-150/50-M12	95	150	M-12	50	5
GT2-70/40-M10	50	70	M-10	40	3
GT2-70/40-M12	50	70	M-12	40	5
GT2-160	160	-	M-12	40	5
GT2-180	180	-	M-12	40	5
GT2-250	250	-	M-12	40	5
GT2-400	400	-	M-12	40	5



ARTHING CLAMP FOR 4 CU. CABLES UPON STRUCTURE

ЗАЖИМЫ ЗАЗЕМЛИТЕЛЕЙ ДЛЯ ЧЕТЫРЁХ МЕДНЫХ ПРОВОДОВ

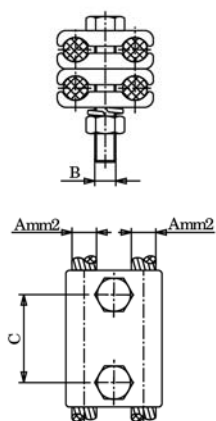

GT4

Referencia Code Шифр	mm ²		B	mm.		Par de apriete Tightening torque Момент затяжки (kg.m)
	A			C		
	Mín.	Máx.				
GT4-70/32-M10	50	70	M-10	32	3	
GT4-70/32-M12	50	70	M-12	32	5	
GT4-70/40-M10	50	70	M-10	40	3	
GT4-70/40-M12	50	70	M-12	40	5	
GT4-150/32-M10	95	150	M-10	32	3	
GT4-150/32-M12	95	150	M-12	32	5	
GT4-150/50-M12	95	150	M-12	50	5	

PARALLEL CLAMP FOR CU. TUBE AND CABLE

ПАРАЛЛЕЛЬНЫЙ ЗАЖИМ ДЛЯ МЕДНОЙ ТРУБЫ И ПРОВОДА

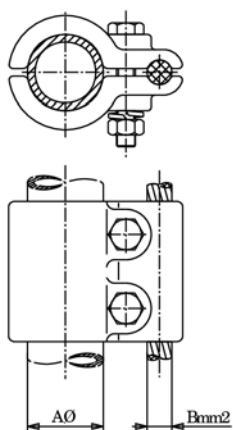

GBC

Referencia Code Шифр	mm	mm ²		Par de apriete Tightening torque Момент затяжки (kg.m)
		B		
		Mín.	Máx.	
GBC-2570	25	50	70	3
GBC-25150	25	95	150	3
GBC-3070	30	50	70	3
GBC-30150	30	95	150	3
GBC-4070	40	50	70	5
GBC-40150	40	95	150	5
GBC-40400	40	300	400	5
GBC-50250	50	180	250	5

EARTHING CLAMP FOR DOUBLE CU. CABLE

ЗАЖИМ ЗАЗЕМЛИТЕЛЯ ДЛЯ ДВОЙНОГО МЕДНОГО ПРОВОДА

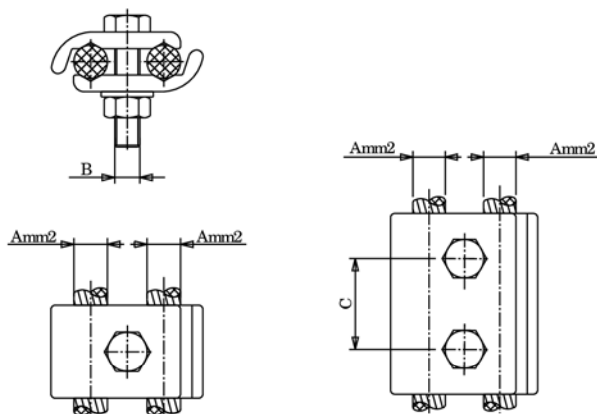

GUE

GU

Referencia Code Шифр	mm ²		B	C	Par de apriete Tightening torque Момент затяжки (kg.m)
	A				
	Mín.	Máx.			
GUE-150/M10	50	160	M-10	-	3
GUE-150/M12	50	160	M-12	-	5
GUE-150/M16	50	160	M-16	-	10
GU-150/32-M10	50	160	M-10	32	3
GU-150/32-M12	50	160	M-12	32	5
GU-150/50-M10	50	160	M-10	50	3
GU-150/50-M12	50	160	M-12	50	5



DOUBLE PARALLEL CLAMP FOR CU. CABLE AND FLATBAR

**ПАРАЛЛЕЛЬНЫЙ ЗАЖИМ ДЛЯ СОЕДИНЕНИЯ ДВОЙНОГО
МЕДНОГО ПРОВОДА С АППАРАТАМИ**

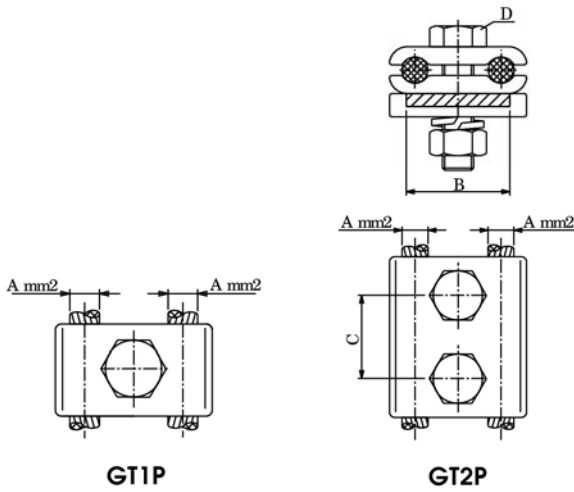

Referencia Code Шифр	mm ²		mm.		D	Par de apriete Tightening torque Момент затяжки (kg.m)
	A		B	C		
	Mín.	Máx.				
GT1P-70	50	70	20-25	-	M-10	3
GT1P-150	95	150	20-25	-	M-10	3

GT2P-70/32	50	70	20-25	32	M-10	3
GT2P-70/40	50	70	20-25	40	M-12	5
GT2P-150/32	95	150	20-25	32	M-10	3
GT2P-150/40/30	95	150	30	40	M-10	3
GT2P-150/40	95	150	40	40	M-12	5
GT2P-150/50	95	150	40	50	M-12	5

CONNECTION CLAMP FOR SPEAR AND CU. CABLE

**СОЕДИНИТЕЛЬНЫЙ ЗАЖИМ ДЛЯ ИЗОЛЯЦИОННОЙ ШТАНГИ И
МЕДНОГО ПРОВОДА**

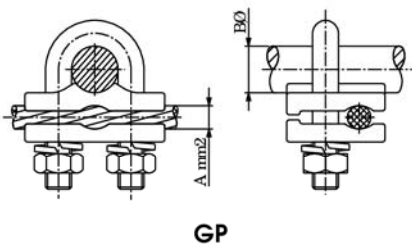

Referencia Code Шифр	mm ²		mm	Par de apriete Tightening torque Момент затяжки (kg.m)
	A		B ø	
	Mín.	Máx.		
GP-1450	50	70	16,4	3
GP-1850	50	70	18,3	3

CONNECTION CLAMP FOR SPEAR AND DOUBLE CU. CABLE

**СОЕДИНИТЕЛЬНЫЙ ЗАЖИМ ДЛЯ ИЗОЛЯЦИОННОЙ ШТАНГИ И
ДВОЙНОГО МЕДНОГО ПРОВОДА**

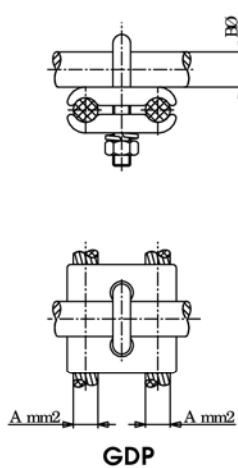

Referencia Code Шифр	mm ²		mm	Par de apriete Tightening torque Момент затяжки (kg.m)
	A		Bø	
	Mín.	Máx.		
GDP-2070	50	70	20	3
GDP-20150	95	150	20	3



SEAL CLAMP FOR STEEL TUBE AND CU. CABLE

УПЛОТНИТЕЛЬНЫЙ ЗАЖИМ ДЛЯ СТАЛЬНОЙ ТРУБЫ И МЕДНОГО ПРОВОДА

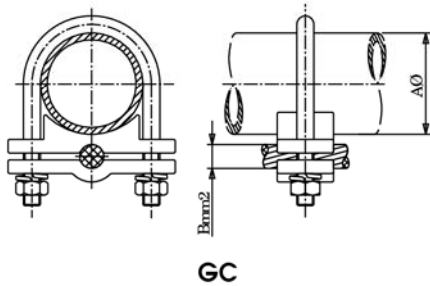

GC

Referencia Code Шифр	mm ²				Par de apriete Tightening torque Момент затяжки (kg.m)
	Aø		B		
	Mín.	Máx.	Mín.	Máx.	
GC-2570	22	26	50	70	3
GC-3270	30	33	50	70	3
GC-42150	38	42	95	150	3
GC-5070	48	50	50	70	3
GC-50150	48	50	95	150	3
GC-6070	58	60	50	70	3
GC-60150	58	60	95	150	3
GC-75150	74	76	95	150	3
GC-90150	87	90	95	150	3

CROSS CLAMP FOR CU. CABLES

ЗАЖИМ ДЛЯ ПЕРЕСЕКАЮЩИХСЯ МЕДНЫХ ПРОВОДОВ

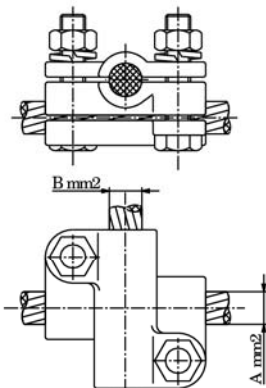

GX

Referencia Code Шифр	mm ²				Par de apriete Tightening torque Момент затяжки (kg.m)
	A		B		
	Mín.	Máx.	Mín.	Máx.	
GX-70	50	70	50	70	3
GX-70150	50	70	90	150	3
GX-150	90	150	90	150	3

FIXING STUD TO STRUCTURE

КРЕПЁЖНЫЙ ФИКСАТОР ДЛЯ МЕДНОГО ПРОВОДА

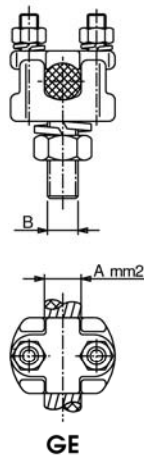

GE

Referencia Code Шифр	mm ²	
	A	B
GE-95/M8	95	M-8
GE-95/M10	95	M-10
GE-150/M10	150	M-10



FIXING STUD TO FLATBAR

КРЕПЁЖНЫЙ ФИКСАТОР ДЛЯ ПРИСОЕДИНЕНИЯ ПРОВОДА

К АППАРАТАМ

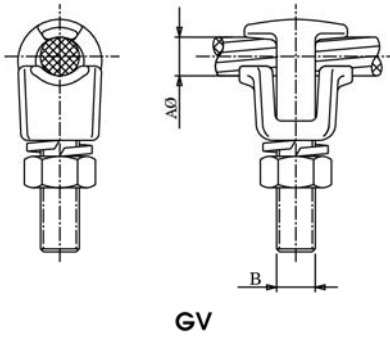

GV

Referencia Code Шифр	AØ		mm	Par de apriete Tightening torque Момент затяжки (kg.m)
	Mín.	Máx.	B	
GV-12/M10	6	12	M-10	3
GV-12/M12	6	12	M-12	5
GV-20/M12	12	20	M-12	5

STRAIGHT AND BEND CONNECTOR FOR CU. CABLE/ROD

ПРЯМОЙ И ПРЯМОУГОЛЬНЫЙ ЗАЖИМ ДЛЯ МЕДНОГО ПРОВОДА

ИЛИ ПРУТКА

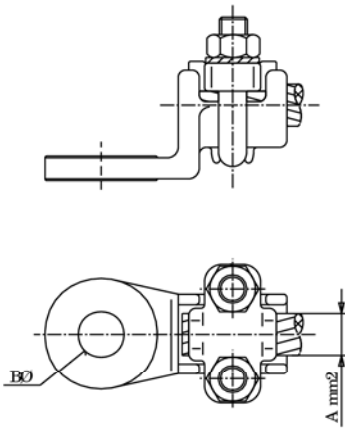

RV

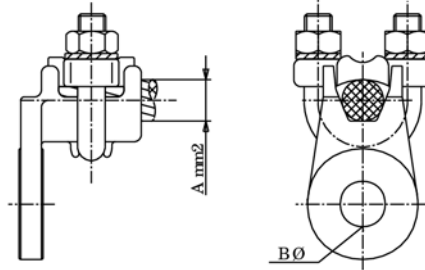

LVP

Referencia Code Шифр	mm ²		mm
	A		BØ
	Mín.	Máx.	
RVP-10/50	10	50	9
RVP-25/70	25	70	12
RVP-25/120	25	120	13
RVP-70/150	70	150	13

LVP-10/50	10	50	9
LVP-25/70	25	70	12
LVP-25/120	25	120	13
LVP-70/150	70	150	13

STRAIGHT JOINING AND "T" CONNECTORS FOR CU. CABLE/ROD

Т-ОБРАЗНЫЙ СТЫКОВОЙ ЗАЖИМ ДЛЯ МЕДНЫХ

ПРОВОДОВ

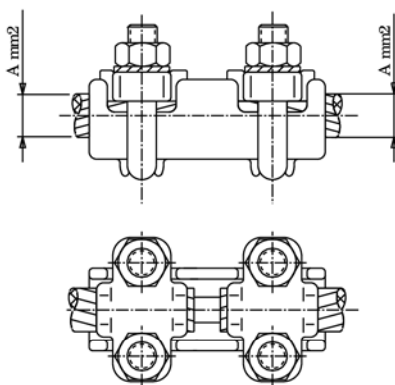

RVV

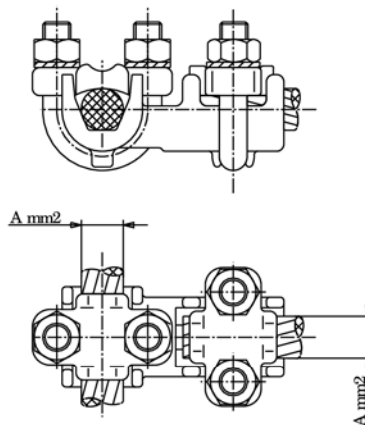

DVV

Referencia Code Шифр	mm ²	
	A	
	Mín.	Máx.
RVV-10/50	10	50
RVV-25/70	25	70
RVV-25/120	25	120
RVV-70/150	70	150

DVV-10/50	10	50
DVV-25/70	25	70
DVV-25/120	25	120
DVV-70/150	70	150



STRIGHT CONNECTOR FOR CU. CABLE TO FLAT

**ПРЯМОЙ ЗАЖИМ ДЛЯ СОЕДИНЕНИЯ МЕДНОГО ПРОВОДА С
ОПОРОЙ**

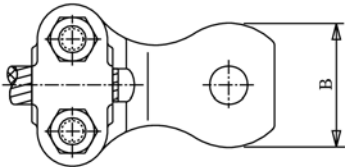
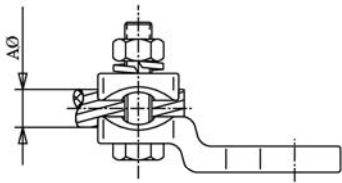

RTP

Referencia Code Шифр	Aø		mm	Par de apriete Tightening torque Момент затяжки (kg.m)
	Mín.	Máx.	B	
RTP-120	9	14	45	3
RTP-250	11	20	45	3
RTP-500	20	30	45	3

COMPRESSION STUD FOR CU. CABLES

ПРЕСЮЩИЙ ЗАЖИМ ДЛЯ МЕДНЫХ ПРОВОДОВ

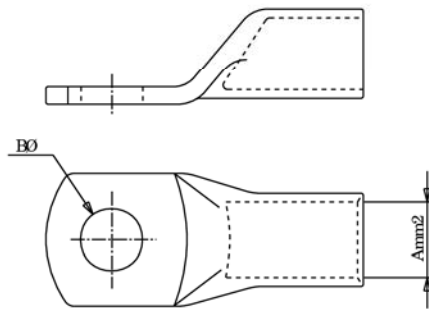

RP

Referencia Code Шифр	A mm ²	Bø
RP-50/10	50	10
RP-50/13	50	13
RP-70/10	70	10
RP-70/13	70	13
RP-95/13	95	13
RP-95/16	95	16
RP-120/14	120	14
RP-120/16	120	16
RP-150/14	150	14
RP-150/16	150	16
RP-185/16	185	16

NOTA: OTRAS MEDIDAS A INDICAR

ПРИМЕЧАНИЕ: ДРУГИЕ РАЗМЕРЫ ПО ЗАПРОСУ

NOTE: D'AUTRES DIMENSIONS À PRECISER

