

U.6

Pag. F1

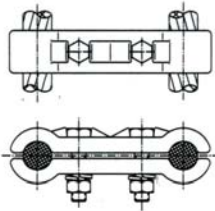

UD

Pag. F1

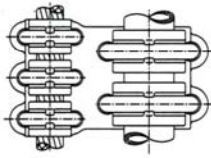

UBC

Pag. F1

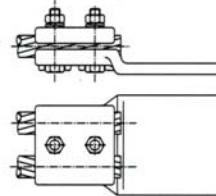

R2CP

Pag. F2

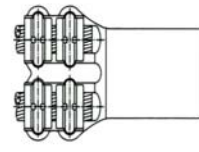

R2CP1

Pag. F2

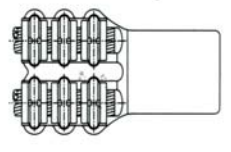

R2CP3

Pag. F3

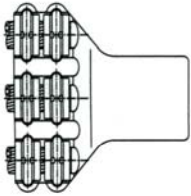

R3CP

Pag. F3

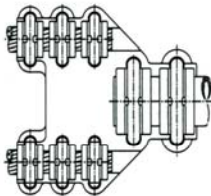

RD3B

Pag. F4

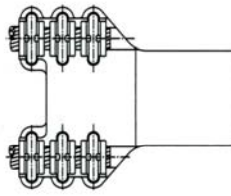

RD3P

Pag. F4

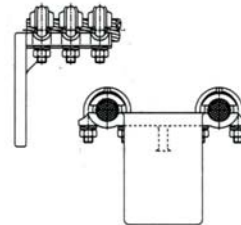

LD3P

Pag. F5

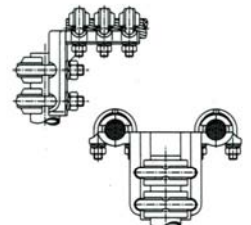

LD3B

Pag. F5

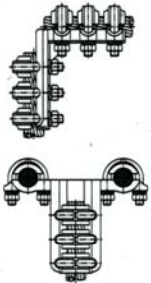

LD3C

Pag. F6

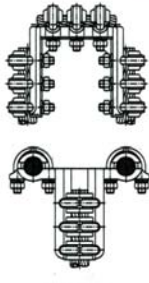

LDX3C

Pag. F6

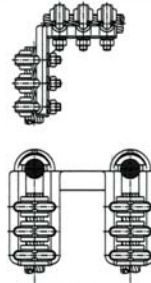

LDD3C

Pag. F7

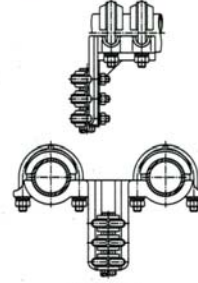

LDBC3

Pag. F7

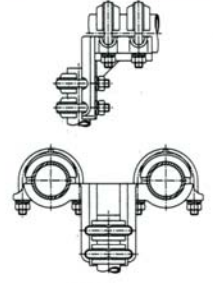

LDBB

Pag. F8



F

DUPLEX CONNECTORS

СДВОЕННЫЕ ЗАЖИМЫ

RACCORDS DUPLEX



DUPLEX CONNECTOR

СДВОЕННЫЙ ЗАЖИМ

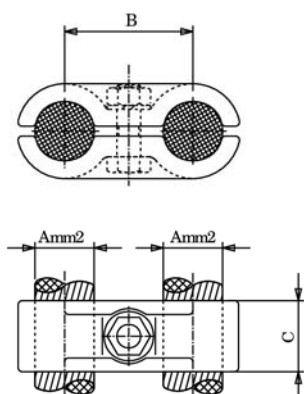

U.6

Referencia Code Шифр	mm ² A	mm		Par de apriete Tightening torque Момент затяжки (kg.m)
		B	C	
U.6-250	180-250	60	35	5
U.6-400	300-400	60	35	5
U.6-500	500	60	35	5

SPACER DUPLEX CU. CABLE

СДВОЕННЫЙ ЗАЖИМ С РАСПОРКОЙ

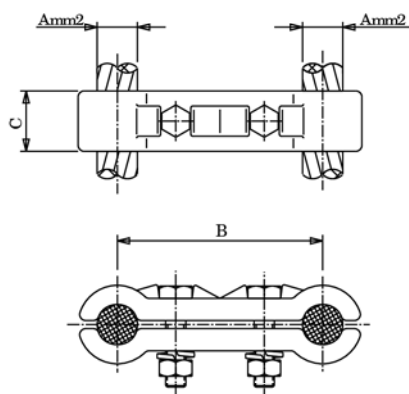

UD

Referencia Code Шифр	mm ² A	mm		Par de apriete Tightening torque Момент затяжки (kg.m)
		B	C	
UD.1-250	180-250	100	30	3
UD.1-400	300-400	100	30	3
UD.1-500	500	100	30	3
UD.15-250	180-250	150	30	3
UD.15-400	300-400	150	30	3
UD.15-500	500	150	30	3

PARALLEL CONNECTOR FOR CU. TUBE AND CU. CABLE

ПАРАЛЛЕЛЬНЫЙ ЗАЖИМ ДЛЯ МЕДНЫХ ТРУБЫ И ПРОВОДА

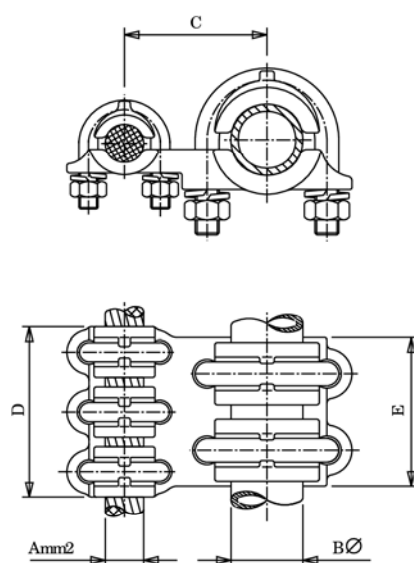

UBC

Referencia Code Шифр	mm ² A	mm				Par de apriete Tightening torque Момент затяжки (kg.m)	
		Bø	C	D	E	A	B
UBC-30150	95-150	30	64	73	62	2	3
UBC-30250	180-250	30	66	80	62	2	3
UBC-30400	300-400	30	70	85	62	2	3
UBC-30500	500	30	76	94	62	3	3
UBC-40150	95-150	40	69	73	67	2	3
UBC-40250	180-250	40	71	80	67	2	3
UBC-40400	300-400	40	75	85	67	2	3
UBC-40500	500	40	81	94	67	3	3
UBC-50150	95-150	50	77	73	75	2	3
UBC-50250	180-250	50	79	80	75	2	3
UBC-50400	300-400	50	83	85	75	2	3
UBC-50500	500	50	89	94	75	3	3
UBC-60150	95-150	60	82	73	80	2	3
UBC-60250	180-250	60	84	80	80	2	3
UBC-60400	300-400	60	88	85	80	2	3
UBC-60500	500	60	94	94	80	3	3



DUPLEX CONNECTOR CU. CABLES TO CU. FLATBAR

СДВОЕННЫЙ ЗАЖИМ ДЛЯ ПРИСОЕДИНЕНИЯ МЕДНЫХ ПРОВОДОВ

К АППАРАТАМ

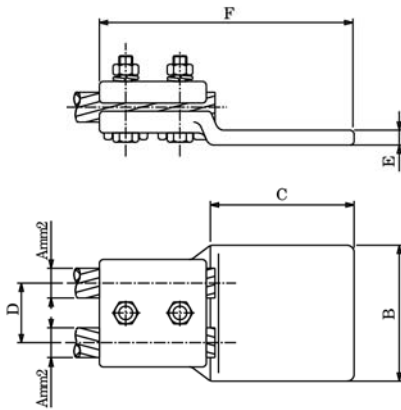

R2CP

Referencia Code Шифр	mm ² A	mm					Par de apriete Tightening torque Момент затяжки (kg.m)
		B	C	D	E	F	
R2CP-15055	95-150	80	80	40	10	185	3
R2CP-15066	95-150	100	100	40	10	185	3
R2CP-25055	180-250	80	80	40	10	185	3
R2CP-25066	180-250	100	100	40	10	185	3
R2CP-40055	300-400	80	80	40	10	185	3
R2CP-40066	300-400	100	100	40	10	185	3

DUPLEX CONNECTOR CU. CABLES TO CU. FLATBAR

СДВОЕННЫЙ ЗАЖИМ ДЛЯ ПРИСОЕДИНЕНИЯ МЕДНЫХ ПРОВОДОВ

К АППАРАТАМ

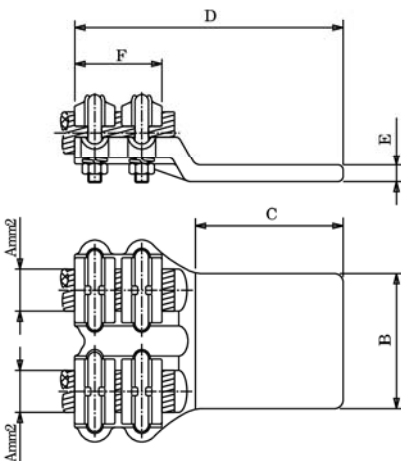

R2CP1

Referencia Code Шифр	mm ² A	mm					Par de apriete Tightening torque Момент затяжки (kg.m)
		B	C	D	E	F	
R2CPI-15044	95-150	60	60	120	8	47	2
R2CPI-15055	95-150	80	80	160	8	47	2
R2CPI-15066	95-150	100	100	160	8	47	2
R2CPI-25044	180-250	60	60	127	9	52	2
R2CPI-25055	180-250	80	80	167	9	52	2
R2CPI-25066	180-250	100	100	167	9	52	2
R2CPI-40044	300-400	60	60	150	10	55	2
R2CPI-40055	300-400	80	80	170	10	55	2
R2CPI-40066	300-400	100	100	170	10	55	2
R2CPI-50044	500	60	60	140	10	62	3
R2CPI-50055	500	80	80	180	10	62	3
R2CPI-50066	500	100	100	180	10	62	2



DUPLEX CONNECTOR CU. CABLES TO CU. FLATBAR

СДВОЕННЫЙ ЗАЖИМ ДЛЯ ПРИСОЕДИНЕНИЯ МЕДНЫХ ПРОВОДОВ

К АППАРАТАМ

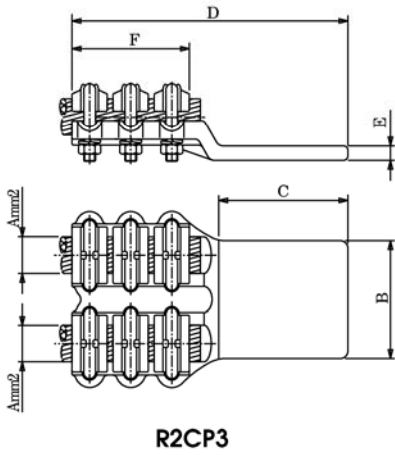

R2CP3

Referencia Code Шифр	mm ²	mm					Par de apriete Tightening torque Момент затяжки (kg.m)
		A	B	C	D	E	
R2CP3-15044	95-150	60	60	152	8	73	2
R2CP3-15055	95-150	80	80	186	8	73	2
R2CP3-15066	95-150	100	100	186	8	73	2
R2CP3-25044	180-250	60	60	155	9	80	2
R2CP3-25055	180-250	80	80	195	9	80	2
R2CP3-25066	180-250	100	100	195	9	80	2
R2CP3-40044	300-400	60	60	160	10	85	2
R2CP3-40055	300-400	80	80	200	10	85	2
R2CP3-40066	300-400	100	100	200	10	85	2
R2CP3-50044	500	60	60	172	10	94	3
R2CP3-50055	500	80	80	212	10	94	3
R2CP3-50066	500	100	100	212	10	94	3

STRAIGHT CONNECTOR FOR 3 CU. CABLES TO FLATBAR

ПРЯМОЙ ЗАЖИМ ДЛЯ ПРИСОЕДИНЕНИЯ ТРЁХ МЕДНЫХ ПРОВОДОВ

К АППАРАТАМ

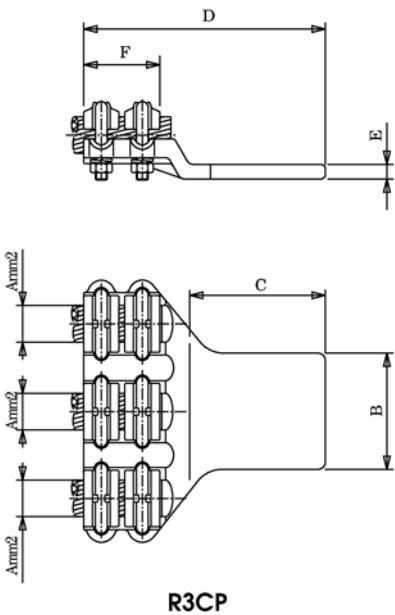

R3CP

Referencia Code Шифр	mm ²	mm					Par de apriete Tightening torque Момент затяжки (kg.m)
		A	B	C	D	E	
R3CP-15055	95-150	80	80	160	8	47	2
R3CP-15066	95-150	100	100	160	8	47	2
R3CP-25055	180-250	80	80	167	9	52	2
R3CP-25066	180-250	100	100	167	9	52	2
R3CP-40055	300-400	80	80	170	10	55	2
R3CP-40066	300-400	100	100	170	10	55	2
R3CP-50055	500	80	80	180	10	62	3
R3CP-50066	500	100	100	180	10	62	3



STRAIGHT CONNECTOR DUPLEX CU. CABLE TO CU. TUBE/STUD

ПРЯМОЙ ЗАЖИМ ДЛЯ СДВОЕННОГО МЕДНОГО ПРОВОДА И МЕДНОЙ

ТРУБЫ ИЛИ СТЕРЖНЯ

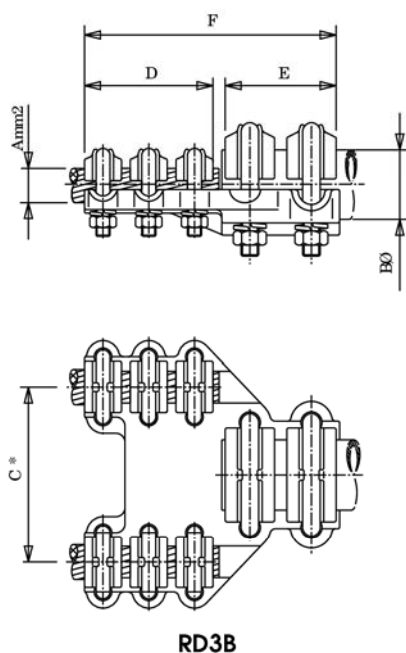

Referencia Code Шифр	mm ²	mm					Par de apriete Tightening torque Момент затяжки (kg.m)	
		A	Ø	C*	D	E	F	A
RD3B.*-15030	95-150	30	SEGUN NOTA	73	62	150	2	3
RD3B.*-15040	95-150	40		73	67	155	2	3
RD3B.*-15050	95-150	50		73	75	163	2	3
RD3B.*-15060	95-150	60		73	80	165	2	3
RD3B.*-25030	185-250	30		80	62	157	2	3
RD3B.*-25040	185-250	40		80	67	162	2	3
RD3B.*-25050	185-250	50		80	75	170	2	3
RD3B.*-25060	185-250	60		80	80	175	2	3
RD3B.*-40030	300-400	30		85	62	162	2	3
RD3B.*-40040	300-400	40		85	67	167	2	3
RD3B.*-40050	300-400	50		85	75	175	2	3
RD3B.*-40060	300-400	60		85	80	180	2	3
RD3B.*-50030	500	30		94	62	171	3	3
RD3B.*-50040	500	40		94	67	176	3	3
RD3B.*-50050	500	50		94	75	183	3	3
RD3B.*-50060	500	60		94	80	190	3	3

NOTA: SEPARACION ENTRE CABLES

ПРИМЕЧАНИЕ: РАССТОЯНИЕ МЕЖДУ ПРОВОДАМИ

NOTE: ÉCARTEMENT DES CABLES

*1=100mm / *15=150mm

*1=100mm / *15=150mm

*1=100mm / *15=150mm

DUPLEX CU. STRAIGHT CONNECTOR TO CU. FLATBAR

СДВОЕННЫЙ МЕДНЫЙ ЗАЖИМ ДЛЯ ПРИСОЕДИНЕНИЯ ПРОВОДОВ

К АППАРАТАМ

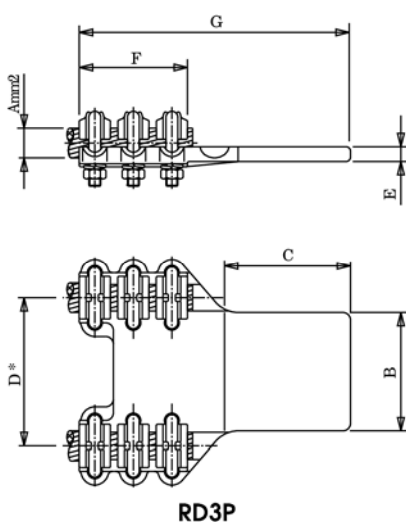

Referencia Code Шифр	mm ²	mm						Par de apriete Tightening torque Момент затяжки (kg.m)	
		A	B	C	D*	E	F	G	A
RD3P.*-15044	95-150	60	60	SEGUN NOTA	8	73	143	2	
RD3P.*-15055	95-150	80	80		8	73	163	2	
RD3P.*-15066	95-150	100	100		8	73	183	2	
RD3P.*-25044	185-250	60	60		8	80	150	2	
RD3P.*-25055	185-250	80	80		8	80	170	2	
RD3P.*-25066	185-250	100	100		8	80	190	2	
RD3P.*-40044	300-400	60	60		10	85	155	2	
RD3P.*-40055	300-400	80	80		10	85	175	2	
RD3P.*-40066	300-400	100	100		10	85	195	2	
RD3P.*-50044	500	60	60		12	94	164	3	
RD3P.*-50055	500	80	80		12	94	184	3	
RD3P.*-50066	500	100	100		12	94	204	3	

NOTA: SEPARACION ENTRE CABLES

ПРИМЕЧАНИЕ: РАССТОЯНИЕ МЕЖДУ ПРОВОДАМИ

NOTE: ÉCARTEMENT DES CABLES

*1=100mm / *15=150mm

*1=100mm / *15=150mm

*1=100mm / *15=150mm



L CONNECTOR DUPLEX CU. CABLE TO CU. FLABAR

L-ОБРАЗНЫЙ ЗАЖИМ ДЛЯ ПРИСОЕДИНЕНИЯ СДВОЕННОГО МЕДНОГО ПРОВОДА К АППАРАТАМ

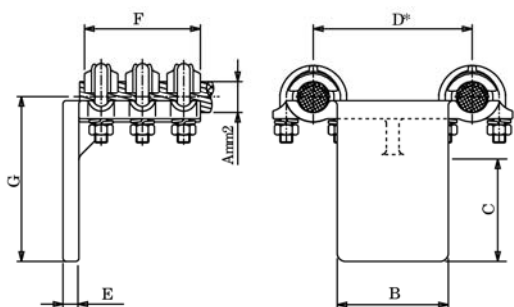

LD3P

Referencia Code Шифр	mm ²	mm						Par de apriete Tightening torque Момент затяжки (kg.m)
		A	B	C	D*	E	F	
LD3P.* -15044	95-150	60	60	SEGUN NOTA	8	73	94	2
LD3P.* -15055	95-150	80	80		8	73	114	2
LD3P.* -15066	95-150	100	100		8	73	134	2
LD3P.* -25044	185-250	60	60		8	80	96	2
LD3P.* -25055	185-250	80	80		9	80	116	2
LD3P.* -25066	185-250	100	100		9	80	136	2
LD3P.* -40044	300-400	60	60		10	85	97	2
LD3P.* -40055	300-400	80	80		10	85	117	2
LD3P.* -40066	300-400	100	100		10	85	137	2
LD3P.* -50044	500	60	60		12	94	98	3
LD3P.* -50055	500	80	80		12	94	118	3
LD3P.* -50066	500	100	100		12	94	138	3

NOTA: SEPARACION ENTRE CABLES

ПРИМЕЧАНИЕ : РАССТОЯНИЕ МЕЖДУ ПРОВОДАМИ

NOTE: ÉCARTEMENT DES CABLES

*1=100mm / *15=150mm

*1=100mm / *15=150mm

*1=100mm / *15=150mm

L CONNECTOR DUPLEX CU. CABLE TO CU. TUBE/STUD

L-ОБРАЗНЫЙ ЗАЖИМ ДЛЯ СОЕДИНЕНИЯ СДВОЕННОГО МЕДНОГО ПРОВОДА С МЕДНОЙ ТРУБОЙ ИЛИ СТЕРЖНЕМ

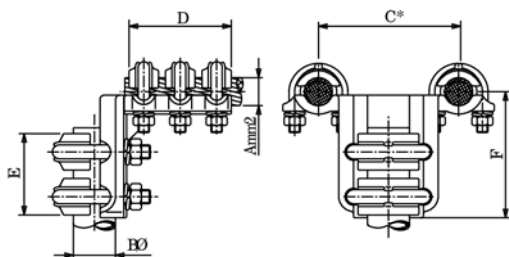

LD3B

Referencia Code Шифр	mm ²	mm					Par de apriete Tightening torque Момент затяжки (kg.m)	
		A	Bø	C*	D	E	F	A
LD3B.* -15030	95-150	30	SEGUN NOTA	73	62	92	2	3
LD3B.* -15040	95-150	40		73	67	97	2	3
LD3B.* -15050	95-150	50		73	75	105	2	3
LD3B.* -15060	95-150	60		73	80	110	2	3
LD3B.* -25030	185-250	30		80	62	94	2	3
LD3B.* -25040	185-250	40		80	67	99	2	3
LD3B.* -25050	185-250	50		80	75	107	2	3
LD3B.* -25060	185-250	60		80	80	112	2	3
LD3B.* -40030	300-400	30		85	62	97	2	3
LD3B.* -40040	300-400	40		85	67	102	2	3
LD3B.* -40050	300-400	50		85	75	110	2	3
LD3B.* -40060	300-400	60		85	80	115	2	3
LD3B.* -50030	500	30		94	62	107	3	3
LD3B.* -50040	500	40		94	67	112	3	3
LD3B.* -50050	500	50		94	75	120	3	3
LD3B.* -50060	500	60		94	80	125	3	3

NOTA: SEPARACION ENTRE CABLES

ПРИМЕЧАНИЕ : РАССТОЯНИЕ МЕЖДУ ПРОВОДАМИ

NOTE: ÉCARTEMENT DES CABLES

*1=100mm / *15=150mm

*1=100mm / *15=150mm

*1=100mm / *15=150mm



L CONNECTOR DUPLEX CU. CABLE TO CU. CABLE

L-ОБРАЗНЫЙ ЗАЖИМ ДЛЯ СОЕДИНЕНИЯ СДВОЕННОГО

МЕДНОГО ПРОВОДА С МЕДНЫМ ПРОВОДОМ

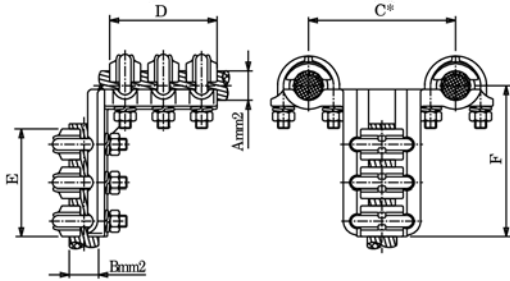

LD3C

Referencia Code Шифр	mm ²		mm				Par de apriete Tightening torque Момент затяжки (kg.m)	
	A	B	C*	D	E	F	A	B
LD3C.* -150	95-150	95-150	SEGUN NOTA	73	73	103	2	2
LD3C.* -150250	95-150	185-250		73	80	110	2	2
LD3C.* -150400	95-150	300-400		73	85	115	2	2
LD3C.* -150500	95-150	500		73	94	124	2	3
LD3C.* -250150	185-250	95-150		80	73	105	2	2
LD3C.* -250	185-250	185-250		80	80	112	2	2
LD3C.* -250400	185-250	300-400		80	85	117	2	2
LD3C.* -250500	185-250	500		80	94	126	2	3
LD3C.* -400150	300-400	95-150		85	73	108	2	2
LD3C.* -400250	300-400	185-250		85	80	115	2	2
LD3C.* -400	300-400	300-400		85	85	120	2	2
LD3C.* -400500	300-400	500		85	94	129	2	3
LD3C.* -500150	500	95-150		94	73	118	3	2
LD3C.* -500250	500	185-250		94	80	125	3	2
LD3C.* -500400	500	300-400		94	85	130	3	2
LD3C.* -500	500	500		94	94	139	3	3

NOTA: SEPARACION ENTRE CABLES

ПРИМЕЧАНИЕ : РАССТОЯНИЕ МЕЖДУ ПРОВОДАМИ

NOTE: ÉCARTEMENT DES CABLES

*1=100mm / *15=150mm

*1=100mm / *15=150mm

*1=100mm / *15=150mm

L CONNECTOR DUPLEX CABLE TO DUPLEX CABLE

L-ОБРАЗНЫЙ ЗАЖИМ ДЛЯ СОЕДИНЕНИЯ СДВОЕННОГО

ПРОВОДА СО ДВОЕННЫМ ПРОВОДОМ

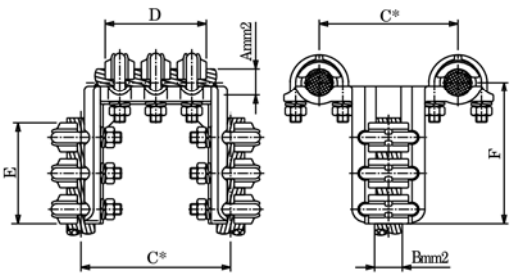

LDX3C

Referencia Code Шифр	mm ²		mm				Par de apriete Tightening torque Момент затяжки (kg.m)	
	A	B	C*	D	E	F	A	B
LDX3C.* -150	95-150	95-150	SEGUN NOTA	73	73	103	2	2
LDX3C.* -150250	95-150	185-250		73	80	110	2	2
LDX3C.* -150400	95-150	300-400		73	85	115	2	2
LDX3C.* -150500	95-150	500		73	94	124	2	3
LDX3C.* -250150	185-250	95-150		80	73	105	2	2
LDX3C.* -250	185-250	185-250		80	80	112	2	2
LDX3C.* -250400	185-250	300-400		80	85	117	2	2
LDX3C.* -250500	185-250	500		80	94	126	2	3
LDX3C.* -400150	300-400	95-150		85	73	108	2	2
LDX3C.* -400250	300-400	185-250		85	80	115	2	2
LDX3C.* -400	300-400	300-400		85	85	120	2	2
LDX3C.* -400500	300-400	500		85	94	129	2	3
LDX3C.* -500150	500	95-150		94	73	118	3	2
LDX3C.* -500250	500	185-250		94	80	125	3	2
LDX3C.* -500400	500	300-400		94	85	130	3	2
LDX3C.* -500500	500	500		94	94	139	3	3

NOTA: SEPARACION ENTRE CABLES

ПРИМЕЧАНИЕ : РАССТОЯНИЕ МЕЖДУ ПРОВОДАМИ

NOTE: ÉCARTEMENT DES CABLES

*1=100mm / *15=150mm

*1=100mm / *15=150mm

*1=100mm / *15=150mm



L CONNECTOR 90° DUPLEX CU. CABLE TO DUPLEX CABLE

L-ОБРАЗНЫЙ ЗАЖИМ ДЛЯ СОЕДИНЕНИЯ СДВОЕННОГО МЕДНОГО

МЕДНОГО ПРОВОДА СО СДВОЕННЫМ ПРОВОДОМ

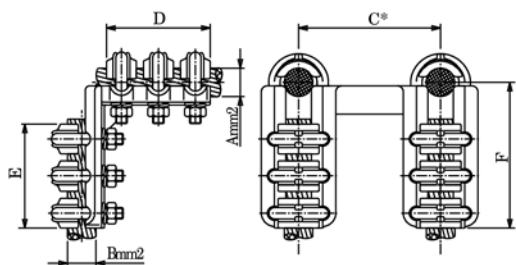

LDD3C

Referencia Code Шифр	mm ²		mm				Par de apriete Tightening torque Момент затяжки (kg.m)	
	A	B	C*	D	E	F	A	B
	SEGUN NOTA							
LDD3C.* -150	95-150	95-150		73	73	103	2	2
LDD3C.* -150250	95-150	185-250		73	80	110	2	2
LDD3C.* -150400	95-150	300-400		73	85	115	2	2
LDD3C.* -150500	95-150	500		73	94	124	2	3
LDD3C.* -250150	185-250	95-150		80	73	105	2	2
LDD3C.* -250	185-250	185-250		80	80	112	2	2
LDD3C.* -250400	185-250	300-400		80	85	117	2	2
LDD3C.* -250500	185-250	500		80	94	126	2	3
LDD3C.* -400150	300-400	95-150		85	73	108	2	2
LDD3C.* -400250	300-400	185-250		85	80	115	2	2
LDD3C.* -400	300-400	300-400		85	85	120	2	2
LDD3C.* -400500	300-400	500		85	94	128	2	3
LDD3C.* -500150	500	95-150		94	73	118	3	2
LDD3C.* -500250	500	185-250		94	80	125	3	2
LDD3C.* -500400	500	300-400		94	85	130	3	2
LDD3C.* -500	500	500		94	94	139	3	3

NOTA: SEPARACION ENTRE CABLES

ПРИМЕЧАНИЕ : РАССТОЯНИЕ МЕЖДУ ПРОВОДАМИ

NOTE: ÉCARTEMENT DES CABLES

*1=100mm / *15=150mm

*1=100mm / *15=150mm

*1=100mm / *15=150mm

L CONNECTOR DUPLEX CU. TUBES TO CU. CABLE

L-ОБРАЗНЫЙ ЗАЖИМ ДЛЯ СОЕДИНЕНИЯ СДВОЕННЫХ МЕДНЫХ

И МЕДНОГО ПРОВОДА

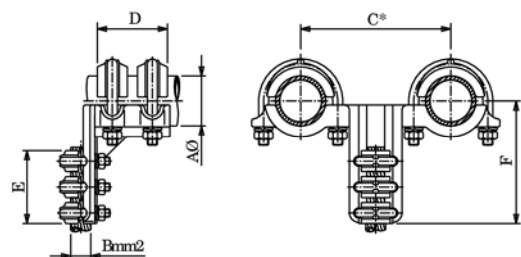

LDBC3

Referencia Code Шифр	Aø	mm ²	mm				Par de apriete Tightening torque Момент затяжки (kg.m)	
		B	C*	D	E	F	A	B
	SEGUN NOTA							
LDBC3.* -30150	30	95-150		62	73	116	3	2
LDBC3.* -30250	30	185-250		62	80	123	3	2
LDBC3.* -30400	30	300-400		62	85	128	3	2
LDBC3.* -30500	30	500		62	94	137	3	3
LDBC3.* -40150	40	95-150		67	73	121	3	2
LDBC3.* -40250	40	185-250		67	80	128	3	2
LDBC3.* -40400	40	300-400		67	85	133	3	2
LDBC3.* -40500	40	500		67	94	142	3	3
LDBC3.* -50150	50	95-150		75	73	128	3	2
LDBC3.* -50250	50	185-250		75	80	135	3	2
LDBC3.* -50400	50	300-400		75	85	140	3	2
LDBC3.* -50500	50	500		75	94	149	3	3

NOTA: SEPARACION ENTRE CABLES

ПРИМЕЧАНИЕ : РАССТОЯНИЕ МЕЖДУ ПРОВОДАМИ

NOTE: ÉCARTEMENT DES CABLES

*1=100mm / *15=150mm

*1=100mm / *15=150mm

*1=100mm / *15=150mm



L CONNECTOR DUPLEX CU. TUBES TO CU. TUBE

L-ОБРАЗНЫЙ ЗАЖИМ ДЛЯ СОЕДИНЕНИЯ СДВОЕННЫХ

МЕДНЫХ ТРУБ С МЕДНОЙ ТРУБОЙ

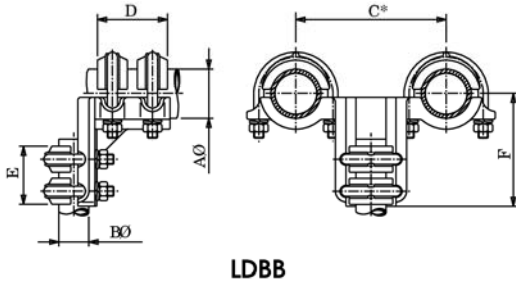

LDBB

Referencia Code Шифр	mm						Par de apriete Tightening torque Момент затяжки (kg.m)
	AØ	BØ	C*	D	E	F	
LDBB.* -3030	30	30	SEGUN NOTA	62	62	105	3
LDBB.* -3040	30	40		62	67	110	3
LDBB.* -3050	30	50		62	75	118	3
LDBB.* -4030	40	30		67	62	110	3
LDBB.* -4040	40	40		67	67	115	3
LDBB.* -4050	40	50		67	75	123	3
LDBB.* -5030	50	30		75	62	117	3
LDBB.* -5040	50	40		75	67	122	3
LDBB.* -5050	50	50		75	75	130	3

NOTA: SEPARACION ENTRE CABLES

ПРИМЕЧАНИЕ: РАССТОЯНИЕ МЕЖДУ ПРОВОДАМИ

NOTE: ÉCARTEMENT DES CABLES

***1=100mm / *15=150mm**

***1=100mm / *15=150mm**

***1=100mm / *15=150mm**

