

MLBCT

Pag. 01

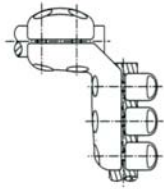

MLBTC3

Pag. 01

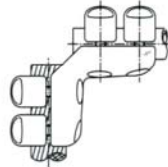

MLBC

Pag. 02

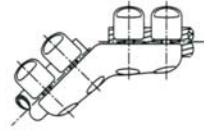

MLBC45°

Pag. 02

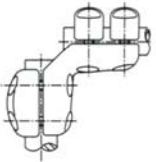

MLBBT

Pag. 03

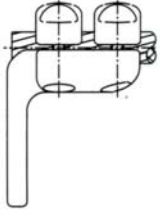

MLCP

Pag. 04

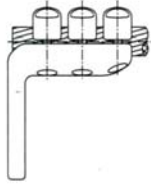

MLC3P

Pag. 05

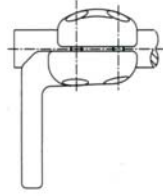

MLBTP

Pag. 05

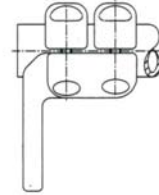

MLBP

Pag. 06

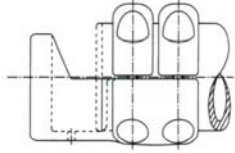

MLBPC

Pag. 06



BEND CONNECTORS
ПРЯМОУГОЛЬНЫЕ ЗАЖИМЫ
RACCORDS COUDES



L CONNECTOR STUD TO CABLE

L-ОБРАЗНЫЙ ЗАЖИМ ДЛЯ СОЕДИНЕНИЯ СТЕРЖНЯ С ПРОВОДОМ

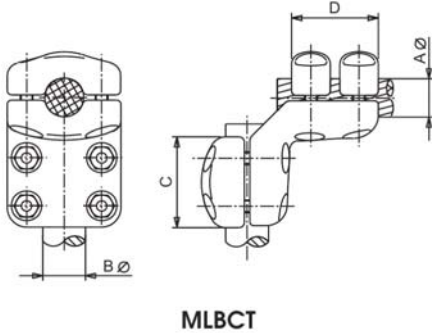

MLBCT

Referencia Code Шифр	mm.					Par de apriete Tightening torque Момент затяжки (kg.m)
	Aø		Bø	C	D	
	Mín.	Máx.				
MLBCT-2515	12	15	25	85	85	5
MLBCT-2518	16	19	25	85	85	5
MLBCT-2522	20	23	25	85	85	5
MLBCT-2525	24	26	25	85	85	5
MLBCT-3015	12	15	30	85	85	5
MLBCT-3018	16	19	30	85	85	5
MLBCT-3022	20	23	30	85	85	5
MLBCT-3025	24	26	30	85	85	5
MLBCT-3030	27	30	30	85	85	5
MLBCT-3032	31	32	30	85	85	5
MLBCT-3035	33	35	30	85	85	5
MLBCT-3038	36	39	30	85	85	5
MLBCT-3043	40	43	30	85	85	5
MLBCT-4015	12	15	40	85	85	5
MLBCT-4018	16	19	40	85	85	5
MLBCT-4022	20	23	40	85	85	5
MLBCT-4025	24	26	40	85	85	5
MLBCT-4030	27	30	40	85	85	5
MLBCT-4032	31	32	40	85	85	5
MLBCT-4035	33	35	40	85	85	5
MLBCT-4038	36	39	40	85	85	5
MLBCT-4043	40	43	40	85	85	5
MLBCT-5025	24	26	50	100	85	5
MLBCT-5030	27	30	50	100	85	5
MLBCT-5032	31	32	50	100	85	5
MLBCT-5035	33	35	50	100	85	5
MLBCT-5038	36	39	50	100	85	5
MLBCT-5043	40	43	50	100	85	5
MLBCT-6025	24	26	60	100	85	5
MLBCT-6030	27	30	60	100	85	5
MLBCT-6032	31	32	60	100	85	5
MLBCT-6035	33	35	60	100	85	5
MLBCT-6038	36	39	60	100	85	5
MLBCT-6043	40	43	60	100	85	5

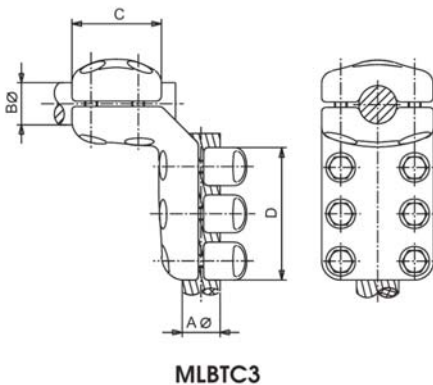

MLBTC3

Referencia Code Шифр	mm.					Par de apriete Tightening torque Момент затяжки (kg.m)
	Aø		Bø	C	D	
	Mín.	Máx.				
MLBTC3-3030	27	30	30	90	138	5
MLBTC3-3032	31	32	30	90	138	5
MLBTC3-3035	33	35	30	90	138	5
MLBTC3-3038	36	39	30	90	138	5
MLBTC3-3043	40	43	30	90	138	5
MLBTC3-4030	27	30	40	90	138	5
MLBTC3-4032	31	32	40	90	138	5
MLBTC3-4035	33	35	40	90	138	5
MLBTC3-4038	36	39	40	90	138	5
MLBTC3-4043	40	43	40	90	138	5
MLBTC3-5030	27	30	50	100	138	5
MLBTC3-5032	31	32	50	100	138	5
MLBTC3-5035	33	35	50	100	138	5
MLBTC3-5038	36	39	50	100	138	5
MLBTC3-5043	40	43	50	100	138	5
MLBTC3-6030	27	30	60	100	138	5
MLBTC3-6032	31	32	60	100	138	5
MLBTC3-6035	33	35	60	100	138	5
MLBTC3-6038	36	39	60	100	138	5
MLBTC3-6043	40	43	60	100	138	5



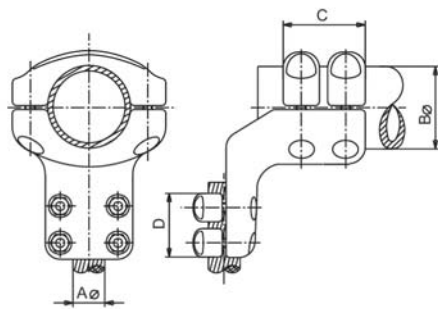
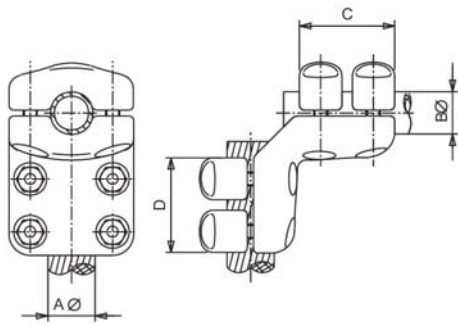

MLBC

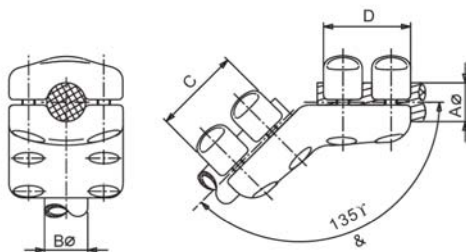

MLBC45°

Referencia Code Шифр	mm.					Par de apriete Tightening torque Момент затяжки (Kgm.)	
	A \varnothing		B \varnothing	C	D	A	B
	Mín.	Máx.					
MLBC-3015	12	15	30	85	85	5	5
MLBC-3018	16	19	30	85	85	5	5
MLBC-3022	20	23	30	85	85	5	5
MLBC-3025	24	26	30	85	85	5	5
MLBC-3030	27	30	30	85	85	5	5
MLBC-3032	31	32	30	85	85	5	5
MLBC-3035	33	35	30	85	85	5	5
MLBC-3038	36	39	30	85	85	5	5
MLBC-3043	40	43	30	85	85	5	5
MLBC-4015	12	15	40	85	85	5	5
MLBC-4018	16	19	40	85	85	5	5
MLBC-4022	20	23	40	85	85	5	5
MLBC-4025	24	26	40	85	85	5	5
MLBC-4030	27	30	40	85	85	5	5
MLBC-4032	31	32	40	85	85	5	5
MLBC-4035	33	35	40	85	85	5	5
MLBC-4038	36	39	40	85	85	5	5
MLBC-4043	40	43	40	85	85	5	5
MLBC-5025	24	26	50	100	85	5	5
MLBC-5030	27	30	50	100	85	5	5
MLBC-5032	31	32	50	100	85	5	5
MLBC-5035	33	35	50	100	85	5	5
MLBC-5038	36	39	50	100	85	5	5
MLBC-5043	40	43	50	100	85	5	5
MLBC-6025	24	26	60	100	85	5	5
MLBC-6030	27	30	60	100	85	5	5
MLBC-6032	31	32	60	100	85	5	5
MLBC-6035	33	35	60	100	85	5	5
MLBC-6038	36	39	60	100	85	5	5
MLBC-6043	40	43	60	100	85	5	5
MLBC-8025	24	26	80	100	85	5	5
MLBC-8030	27	30	80	100	85	5	5
MLBC-8032	31	32	80	100	85	5	5
MLBC-8035	33	35	80	100	85	5	5
MLBC-8038	36	39	80	100	85	5	5
MLBC-8043	40	43	80	100	85	5	5
MLBC-10030	27	30	100	100	85	5	5
MLBC-10032	31	32	100	100	85	5	5
MLBC-10035	33	35	100	100	85	5	5
MLBC-10038	36	39	100	100	85	5	5
MLBC-10043	40	43	100	100	85	5	5
MLBC-12030	27	30	120	110	85	5	7
MLBC-12032	31	32	120	110	85	5	7
MLBC-12035	33	35	120	110	85	5	7
MLBC-12038	36	39	120	110	85	5	7
MLBC-12043	40	43	120	110	85	5	7
MLBC-15030	27	30	150	120	85	5	7
MLBC-15032	31	32	150	120	85	5	7
MLBC-15035	33	35	150	120	85	5	7
MLBC-15038	36	39	150	120	85	5	7
MLBC-15043	40	43	150	120	85	5	7

NOTA : OTROS ANGULOS A INDICAR - EJEMPLO: MLBC45°

ПРИМЕЧАНИЕ: УТОЧНИТЬ ДРУГИЕ УГЛЫ

NOTE : D'AUTRES ANGLES À PRÉCISER - EXEMPLE: MLBC45°



L CONNECTOR TUBE TO STUD

L-ОБРАЗНЫЙ ЗАЖИМ ДЛЯ СОЕДИНЕНИЯ ТРУБЫ СО СТЕРЖНЕМ

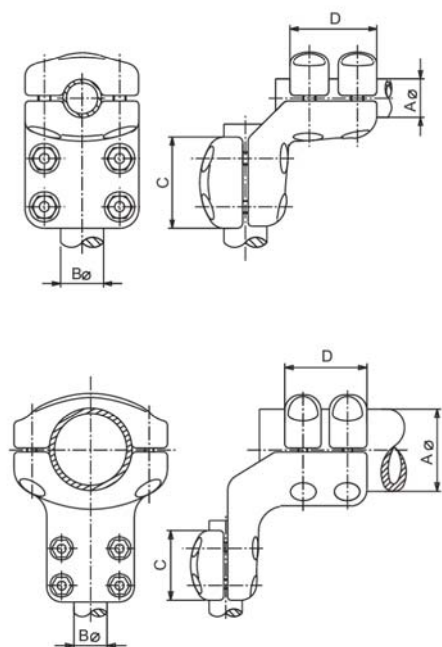

MLBBT

Referencia Code Шифр	mm.				Par de apriete Tightening torque Момент затяжки (kg.m)	
	Aø	Bø	C	D	A	B
MLBBT-3030	30	30	85	85	5	5
MLBBT-4030	40	30	85	85	5	5
MLBBT-4050	40	50	100	85	5	5
MLBBT-4060	40	60	100	85	5	5
MLBBT-5030	50	30	85	100	5	5
MLBBT-5040	50	40	85	100	5	5
MLBBT-5060	50	60	100	100	5	5
MLBBT-6030	60	30	85	100	5	5
MLBBT-6040	60	40	85	100	5	5
MLBBT-6050	60	50	100	100	5	5
MLBBT-8030	80	30	85	100	5	5
MLBBT-8040	80	40	90	100	5	5
MLBBT-8050	80	50	100	100	5	5
MLBBT-8060	80	60	100	100	5	5
MLBBT-10030	100	30	90	100	5	5
MLBBT-10040	100	40	90	100	5	5
MLBBT-10050	100	50	100	100	5	5
MLBBT-10060	100	60	100	100	5	5
MLBBT-12030	120	30	90	110	7	5
MLBBT-12040	120	40	90	110	7	5
MLBBT-12050	120	50	100	110	7	5
MLBBT-12060	120	60	100	110	7	5
MLBBT-15030	150	30	90	120	7	5
MLBBT-15040	150	40	90	120	7	5
MLBBT-15050	150	50	100	120	7	5
MLBBT-15060	150	60	100	120	7	5



L CONNECTOR CABLE TO FLATBAR

L-ОБРАЗНЫЙ ЗАЖИМ ДЛЯ ПРИСОЕДИНЕНИЯ ПРОВОДА К АППАРАТАМ

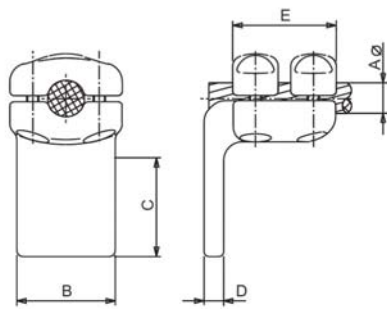

MLCP

Referencia Code Шифр	mm.						Par de apriete Tightening torque Момент затяжки (kg.m)
	Aø		B	C	D	E	
	Mín.	Máx.					
MLCP-1533	12	15	50	50	15	82	3
MLCP-1544	12	15	60	60	15	82	3
MLCP-1555	12	15	80	80	15	82	3
MLCP-1566	12	15	100	100	15	82	3
MLCP-1588	12	15	125	125	15	82	3
MLCP-1833	16	19	50	50	15	82	3
MLCP-1844	16	19	60	60	15	82	3
MLCP-1855	16	19	80	80	15	82	3
MLCP-1866	16	19	100	100	15	82	3
MLCP-1888	16	19	125	125	15	82	3
MLCP-2233	20	23	50	50	15	82	3
MLCP-2244	20	23	60	60	15	82	3
MLCP-2255	20	23	80	80	15	82	3
MLCP-2266	20	23	100	100	15	82	3
MLCP-2288	20	23	125	125	15	82	3
MLCP-2544	24	26	60	60	15	82	3
MLCP-2555	24	26	80	80	15	82	3
MLCP-2566	24	26	100	100	15	82	3
MLCP-2588	24	26	125	125	15	82	3
MLCP-3044	27	30	60	60	15	82	3
MLCP-3055	27	30	80	80	15	82	3
MLCP-3066	27	30	100	100	15	82	3
MLCP-3088	27	30	125	125	15	82	3
MLCP-3255	31	32	80	80	15	85	5
MLCP-3266	31	32	100	100	15	85	5
MLCP-3288	31	32	125	125	15	85	5
MLCP-3555	33	35	80	80	15	85	5
MLCP-3566	33	35	100	100	15	85	5
MLCP-3588	33	35	125	125	15	85	5
MLCP-3855	36	39	80	80	15	85	5
MLCP-3866	36	39	100	100	15	85	5
MLCP-3888	36	39	125	125	15	85	5
MLCP-4355	40	43	80	80	15	85	5
MLCP-4366	40	43	100	100	15	85	5
MLCP-4388	40	43	125	125	15	85	5

NOTA : OTROS ANGULOS A INDICAR - EJEMPLO: MLCP45°

ПРИМЕЧАНИЕ : УТОЧНИТЬ ДРУГИЕ УГЛЫ- ПРИМЕР: MLCP45°

NOTE : D'AUTRES ANGLES À PRÉCISER - EXEMPLE: MLCP45°



L CONNECTOR CABLE TO FLATBAR

L-ОБРАЗНЫЙ ЗАЖИМ ДЛЯ ПРИСОЕДИНЕНИЯ ПРОВОДА К АППАРАТАМ

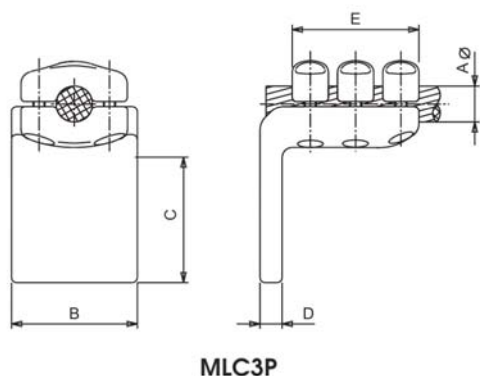

Referencia Code Шифр	mm.						Par de apriete Tightening torque Момент затяжки (kg.m)
	Aø		B	C	D	E	
	Mín.	Máx.					
MLC3P-3255	31	32	80	80	20	128	5
MLC3P-3266	31	32	100	100	20	128	5
MLC3P-3288	31	32	125	125	20	128	5
MLC3P-3555	33	35	80	80	20	128	5
MLC3P-3566	33	35	100	100	20	128	5
MLC3P-3588	33	35	125	125	20	128	5
MLC3P-3855	36	39	80	80	20	128	5
MLC3P-3866	36	39	100	100	20	128	5
MLC3P-3888	36	39	125	125	20	128	5
MLC3P-4355	40	43	80	80	20	128	5
MLC3P-4366	40	43	100	100	20	128	5
MLC3P-4388	40	43	125	125	20	128	5

NOTA : OTROS ANGULOS A INDICAR - EJEMPLO: MLC3P45°
 ПРИМЕЧАНИЕ : УТОЧНИТЬ ДРУГИЕ УГЛЫ - ПРИМЕР: MLC3P45°
 NOTE : D'AUTRES ANGLES À PRÉCISER - EXEMPLE: MLC3P45°

L CONNECTOR STUD TO FLATBAR

L-ОБРАЗНЫЙ ЗАЖИМ ДЛЯ ПРИСОЕДИНЕНИЯ СТЕРЖНЯ К АППАРАТАМ

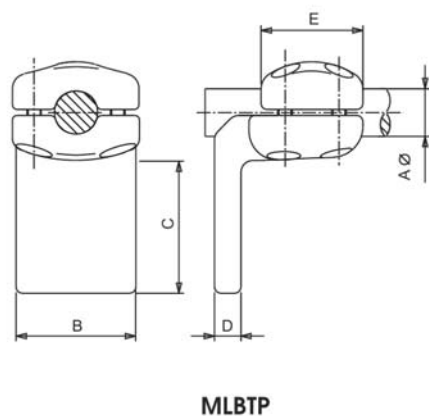

Referencia Code Шифр	mm.					Par de apriete Tightening torque Момент затяжки (kg.m)
	Aø	B	C	D	E	
MLBTP-3055	30	80	80	15	85	3
MLBTP-3066	30	100	100	15	85	3
MLBTP-3088	30	125	125	15	85	3
MLBTP-4055	40	80	80	15	85	5
MLBTP-4066	40	100	100	15	85	5
MLBTP-4088	40	125	125	15	85	5
MLBTP-5055	50	80	80	15	100	5
MLBTP-5066	50	100	100	15	100	5
MLBTP-5088	50	125	125	15	100	5
MLBTP-6055	60	80	80	15	100	5
MLBTP-6066	60	100	100	15	100	5
MLBTP-6088	60	125	125	15	100	5



L CONNECTOR TUBE TO FLATBAR

L-ОБРАЗНЫЙ ЗАЖИМ ДЛЯ ПРИСОЕДИНЕНИЯ ТРУБЫ К АППАРАТАМ

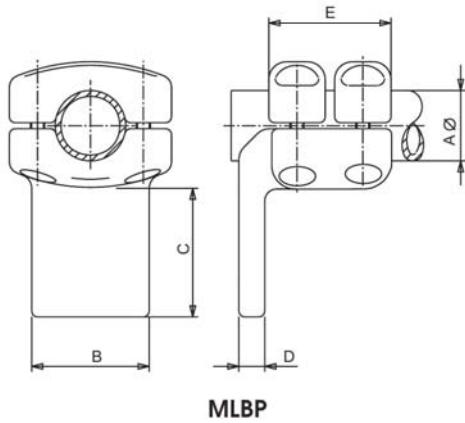

Referencia Code Шифр	mm.					Par de apriete Tightening torque Момент затяжки (kg.m)
	A \varnothing	B	C	D	E	
MLBP-4055	40	80	80	15	85	5
MLBP-4066	40	100	100	15	85	5
MLBP-4088	40	125	125	15	85	5
MLBP-5055	50	80	80	15	100	5
MLBP-5066	50	100	100	15	100	5
MLBP-5088	50	125	125	15	100	5
MLBP-6055	60	80	80	15	100	5
MLBP-6066	60	100	100	15	100	5
MLBP-6088	60	125	125	15	100	5
MLBP-8055	80	80	80	15	100	5
MLBP-8066	80	100	100	15	100	5
MLBP-8088	80	125	125	15	100	5
MLBP-10055	100	80	80	15	100	5
MLBP-10066	100	100	100	15	100	5
MLBP-10088	100	125	125	15	100	5
MLBP-12066	120	100	100	15	110	7
MLBP-12088	120	125	125	15	110	7
MLBP-15066	150	100	100	15	120	7
MLBP-15088	150	125	125	15	120	7

STRAIGHT CONNECTOR UNION TUBE TO FLATBAR

ПРЯМОЙ ЗАЖИМ ДЛЯ ПРИСОЕДИНЕНИЯ ТРУБЫ К АППАРАТАМ

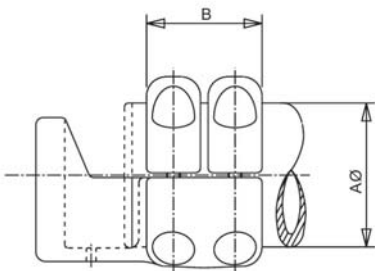

Referencia Code Шифр	mm		Par de apriete Tightening torque Момент затяжки (kg.m)
	A \varnothing	B	
MLBPC-100	100	100	5
MLBPC-120	120	110	7
MLBPC-150	150	120	7

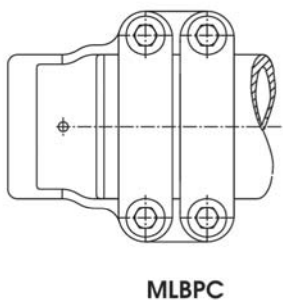

PLETINA TIPO A

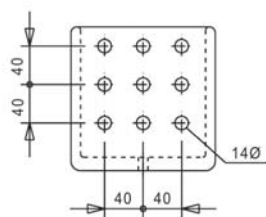

PLETINA TIPO B

